

U1000MkII WM

U1000MKII-WM:Wall-Mounted Ultrasonic Flow Meter
U1000MKII-HM:Wall-Mounted Ultrasonic Heat Meter

User Manual



Micronics Ltd, Knaves Beech Business Centre,
Davies Way, Loudwater, High Wycombe, Bucks HP10 9QR

Telephone: +44(0)1628 810456 **E-mail:** sales@micronicsltd.co.uk

www.micronicsflowmeters.com

DOCUMENT AUTHORITY

Issue	2.0			
Originator	Micronics Ltd			
Checked				
Approved				
Date	12/12/2022			

CONTENTS

1	INTRODUCTION	4
1.1	General Description	4
1.2	How Does It Work?.....	5
1.3	Package Contents	6
1.4	Display.....	7
1.5	Quick Start Procedure	8
1.6	Output and Communication Options	8
2	INSTALLATION.....	9
2.1	Positioning.....	9
2.1.1	Additional Considerations for Locating Heat Meter versions	10
2.1.2	Clean the Pipe's Flow Sensor Contact Area	10
2.2	Connect Power and Signal Cables	11
2.2.1	Power Supply	11
2.2.2	Guiderail/Flow Sensors.....	11
2.2.3	PT100 Sensors (Heat Meter versions only)	11
2.2.4	Pulse Output Connection.....	12
2.2.5	Current Output (if fitted)	12
2.2.6	Modbus/M-Bus Connections (if fitted)	13
2.3	Switch On	14
2.3.1	U1000MkII WM Flow Meter	14
2.3.2	U1000MkII WM Heat Meter	15
2.4	Assemble the Guiderail.....	16
2.5	Adjust Flow Sensor Separation.....	16
2.6	Apply Gel Pads.....	16
2.7	Clamp Guiderail to Pipe.....	16
2.8	Calibrate the PT100 Temperature Sensors (Heat Meter versions only)	17
2.9	Attach the PT100 Sensors (Heat Meter versions only).....	17
2.10	Zero offset the Flow Sensors	18
2.11	Normal Operation	18
2.11.1	U1000MkII-WM Flow Meter	18
2.11.2	U1000MkII-WM Heat Meter	19
2.12	Totals and Rollover.....	19
2.13	Troubleshooting the Flow Reading	20
2.14	Resetting the Flow Direction	21
3	MENUS.....	21
3.1	Accessing the Menus.....	22
3.2	Setup Menu	23
3.2.1	Pipe Characteristics.....	23

3.2.2	Fluid Characteristics	23
3.2.3	System Units	24
3.2.4	Instrument Configuration	24
3.2.5	Separation Distance	25
3.3	Current Output Menu	25
3.4	Modbus Setup Menu.....	25
3.5	M-Bus Setup Menu	26
3.6	Pulse Output Menu	27
3.6.1	Volume Pulse	27
3.6.2	Flow Alarm	27
3.6.3	Energy Pulse (Heat Meter versions only).....	28
3.6.4	Frequency	28
3.7	Calibration Menu	28
3.8	Volume Totals Menu.....	29
3.8.1	Volume Totals Reset	29
3.8.2	Totals Format Type	29
3.9	Diagnostics Menu	30
4	OUTPUTS	31
4.1	Pulse Output.....	31
4.1.1	Volumetric Pulse.....	31
4.1.2	Frequency Mode.....	32
4.1.3	Energy Pulse	32
4.1.4	Alarm.....	32
4.2	4–20mA Current Output - Optional	32
4.3	Modbus - Optional	33
4.4	M-Bus - Optional.....	33
5	DEFAULT VALUES AND ERROR CODES.....	34
5.1	Defaults	34
5.2	Error and Warning Messages	34
5.2.1	Error Messages	34
5.2.2	Example Error Messages	35
5.2.3	Modbus Error Messages (if Modbus fitted)	35
5.2.4	Flow Errors	35
5.2.5	Flow Warnings.....	36
5.2.6	Data Entry Errors.....	36
6	APPENDIX.....	37
6.1	Specification	37
7	FIXING AND ENCLOSURE DIMENSIONS.....	39

8	DECLARATION OF CONFORMITY.....	40
	Figure 1: Principle of Transit-Time operation	5
	Figure 2: Package Contents.....	6
	Figure 3: U1000MKII WM display (Heat Meter model shown)	7
	Figure 4: Location of unit	9
	Figure 5: Typical setup of U1000MkII-WM Heat Meter for boiler applications	10
	Figure 6: Terminal blocks and connectors.....	11
	Figure 7: U1000MKII WM Heat Meter PT100 Temperature Probe Wiring	12
	Figure 8: Fully assembled U1000MkII-WM Heat Meter unit	17
	Figure 9: Volume / Energy Pulse Width	31
	Figure 10: Default 4–20mA values	32

1 INTRODUCTION

1.1 General Description

This manual describes the installation and use of the two models in the U1000MkII WM range:

- **U1000MkII WM Flow Meter** is a wall-mounted control unit with a clamp-on ultrasonic flow sensors for measuring flow rate and total flow with a volume pulse output. It can be used as a standalone meter or as part of an integral management system.
- **U1000MkII WM Heat Meter** is a wall-mounted control unit with a clamp-on ultrasonic flow sensors and separate pair of PT100 thermal sensors. It uses ultrasound to measure flow rate and is also equipped with PT100 temperature sensors to measure flow and return temperatures. The U1000MKII WM Heat Meter displays energy rate and totalised energy with pulse output and communication options, so it can be used as a standalone meter or as an integral part of Automatic Monitoring & Targeting (aM&T) or a Building Energy Management System (BEMS).

The ultrasonic flow sensor attaches to the pipe using the supplied hose clips. The sensors operate on mild steel, stainless steel, copper, and plastic pipes with internal diameter in the range 20 mm (0.8”) to 110 mm (4.3”), or 105 mm (4.1”) to 215 mm (8.5”) depending on the product purchased. The wall-mounted electronics and control unit requires an external 12–24 VDC or 24 VAC power supply (7 VA minimum), optionally supplied.

Both models can be supplied as pulse output only units, Pulse O/P is always present, or with optional 4–20mA flow proportional output, and/or Modbus, M-Bus or BACnet Communication Options.

Typical applications:

U1000MkII WM Flow Meter

Hot water metering and flow measurement
Flow measurement for heat metering
Chilled water metering and flow measurement
Potable water metering and flow measurement
Process water metering and flow measurement
Ultra-pure water metering and flow measurement.

U1000MkII WM Heat Meter

Hot water metering and flow measurement
Flow measurement for Energy Metering
Chilled water metering and flow measurement

NOTE:

U1000MkII WM Heat Meter units are preconfigured as follows:

- **Instrument Type:** Heating
- **Installation:** Flow
- **Fluid:** Water

Flow and *Return* refer to the location of the flow measurement relative to flow circuit.

1.2 How Does It Work?

The U1000MKII WM uses a cross correlation transit time algorithm to provide accurate flow measurements.

An ultrasonic beam of a given frequency is generated by applying a repetitive voltage pulse to the transducer crystals. This transmission goes first from the downstream transducer to the upstream transducer as shown in the upper half of Figure 1. The transmission is then made in the reverse direction, being sent from the upstream transducer to the downstream transducer as shown in the lower half of Figure 1. The speed at which the ultrasound is transmitted through the liquid is accelerated slightly by the velocity of the liquid through the pipe. The subsequent time difference $T1-T2$ is directly proportional to the liquid flow velocity.

With Heat Meter models, two temperature sensors measure the difference in temperature between the flow and return of the flow system being monitored. The temperature difference, in combination with the volume of water that has flowed through the system, is then used to calculate the energy transferred to or from the water.

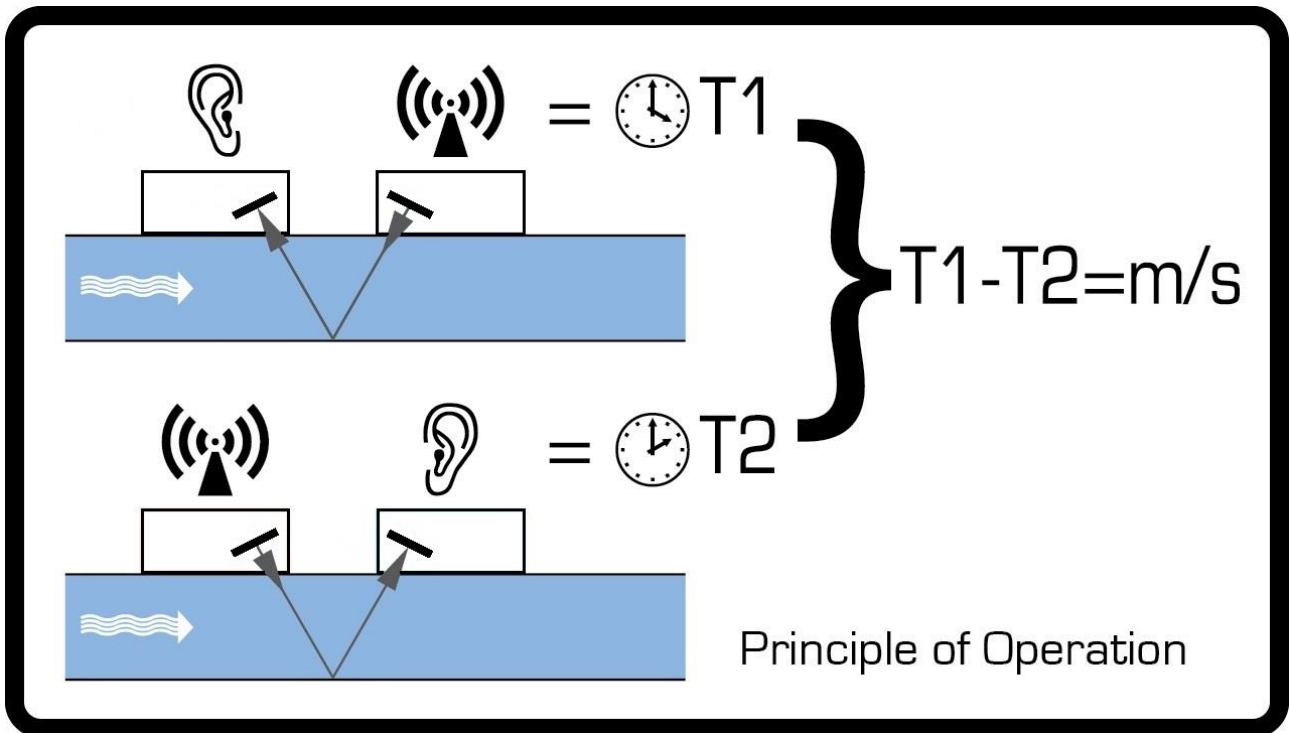

Figure 1: Principle of Transit-Time operation

1.3 Package Contents

The unit consists of:

1. **Wall-mounted electronics and control unit**
Consisting of the keypad with display, power, communications, and sensor connections.
2. **Ultrasonic Flow Sensors**
Two transducers for flow measurement with VHB gel pads to ensure good contact with pipework.

In addition, the kit contains (see [Figure 2: Package Contents](#)):

3. Guide rail
4. Heat Meter versions only: Non-releasable stainless-steel cable ties for temperature sensors and cables (4)
5. Quick release clamps for use with pipes with an OD of 25–70 mm (p/n 225-5007) or 51–127 mm (2) (p/n 225–5001)
6. Heat Meter versions only: PT100 temperature sensors with 3 m cable (2)
7. 12 V power supply and adapters (optionally supplied).



Figure 2: Package Contents

1.4 Display

The U1000MKII WM display comprises:

- One 2–line x 16-character LCD with backlight
- Four tactile key switches
- Two LEDs

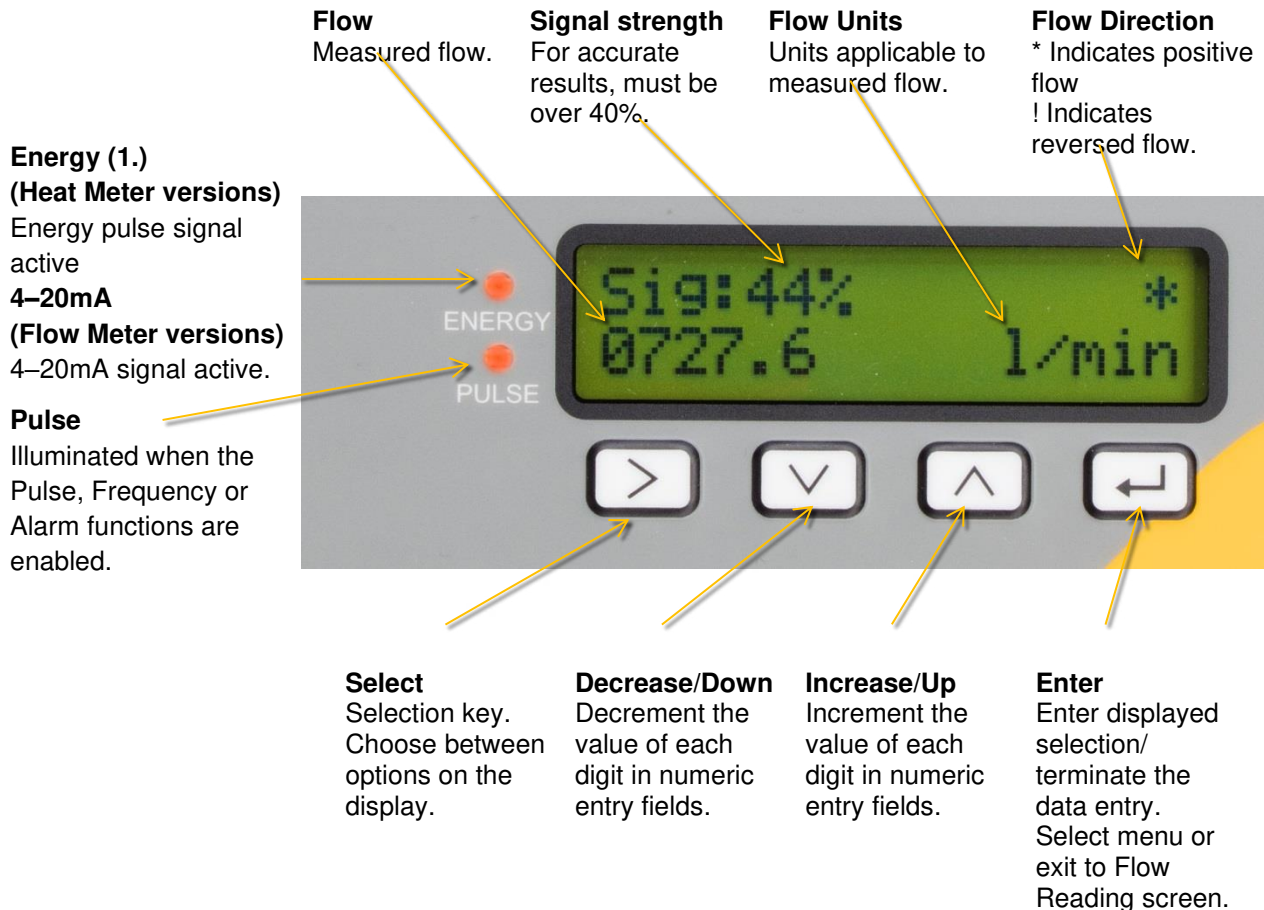

Figure 3: U1000MKII WM display (Heat Meter model shown)

1. The front panel will indicate “**Energy**” (shown here) or “**4–20mA**” for HM or FM variants respectively.

1.5 Quick Start Procedure

The following procedure summarises the steps required to set up the U1000MkII WM. Please refer to the referenced sections for full details.

1. Identify a suitable location for the sensors and guide rail on a straight length of pipe clear of bends and valves or similar obstructions (See Section 2.1 Positioning). Make a note of the pipe internal diameter, wall thickness and material at this point.
2. Connect the wall-mount electronics unit:
 - a. Fix the unit to a convenient location on a wall within 5 m of the pipe location.
 - b. Connect to a 12–24 VDC or 24 VAC power supply (7 VA minimum per instrument) - See Section 2.2.1 Power Supply.
 - c. Switch on and program to determine the correct sensor separation (See Section 2.3 Switch On).
3. Attach the flow sensors and guide rail:
 - a. Set the flow sensors to the correct separation (see Section 2.5 Adjust Flow Sensor Separation).
 - b. Apply the gel pads to the sensors (see Section 2.6 Apply Gel Pads).
 - c. Mount the sensor and guide rail assembly onto the pipe using the supplied clamps (see Section 2.7 Clamp Guiderail to Pipe).
4. Connect the sensors to the wall-mounted electronics unit (see Section 2.2 Connect Power and Signal Cables).
5. Heat Meter versions only: Connect the PT100 temperature sensors to the electronics unit (see Section 2.2.3) and attach to the flow and return pipes (see Section 2.1).
6. Check that flow readings can be obtained (see Section 2.11 Normal Operation).
7. Check meter flow readings at physical zero flow. If there is a Measured Flow then consider zeroing the sensors see section 3.7 Calibration Menu.

1.6 Output and Communication Options

The Wall Mount may have up to 2 modules present; from a 4–20mA or a Comms module which are M-Bus Modbus or BACnet. See the relevant sections.

The comms modules M-Bus, Modbus and BACnet now have separate documents.

To configure a Pulse Output option, see Section 2.2.4 Pulse Output Connection.

To configure the 4–20mA Output, see Section 2.2.5 Current Output (if fitted).

To configure the Modbus interface, see Section 2.2.6 Modbus/M-Bus Connections (if fitted). The address, data rate, and configuration of the instrument must be set using the Modbus Menu (see Section 3.4 Modbus Setup Menu). The default address is 1, the default data rate is 38400 baud, and the default Comms configuration is 8-None-2.

To configure M-Bus communication, see Section 2.2.6 Modbus/M-Bus Connections (if fitted). The primary and secondary addresses must be set using the M-Bus Menu (see Section 3.5 M-Bus Setup Menu). The message format may need to be changed to match the Master Controller (BMS etc), see M-Bus manual.

2 INSTALLATION

2.1 Positioning

For accurate measurements, the U1000MKII WM guide rail and sensors must be installed at a position where the fluid flows uniformly. Flow profile distortions can result from upstream disturbance such as bends, tees, valves, pumps, and other similar obstructions. To ensure a uniform flow profile, the unit must be mounted away from any cause of flow disturbance.

As a guide, we suggest this is best achieved by ensuring there is a straight length of pipe upstream of the transducers of at least 10 times the pipe diameter, and 5 times the pipe diameter on the downstream side, as shown in [Figure 4: Location of unit](#), but this may vary. Flow Measurements can be made on shorter lengths of straight pipe, but when the transducers are mounted this close to any obstruction the resulting errors can be unpredictable.

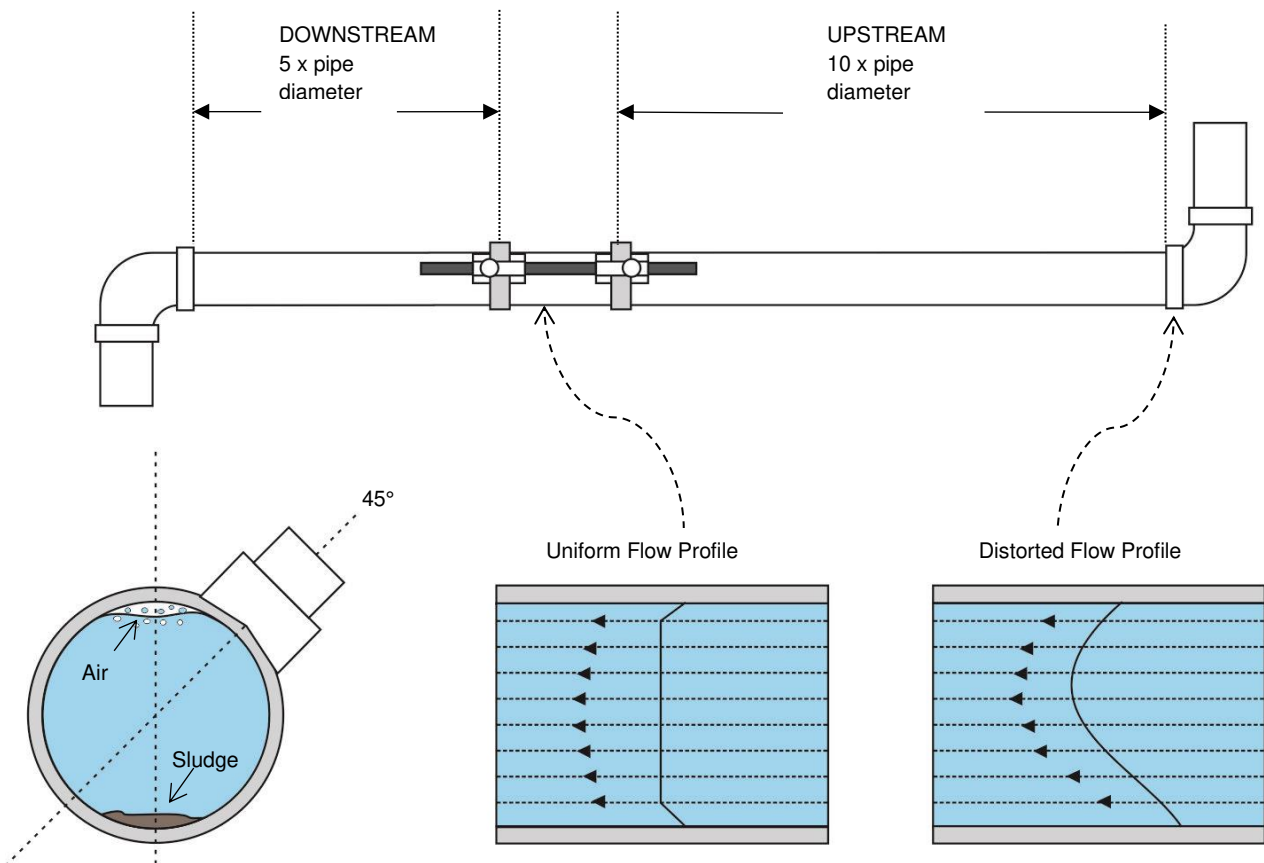

Figure 4: Location of unit

To obtain the most accurate results, the condition of both the liquid and the pipe must be suitable to allow ultrasound transmission along the predetermined path.

In many applications, an even flow velocity profile over a full 360° is unattainable due, for example, to the presence of air turbulence at the top of the flow and possibly sludge at the bottom of the pipe. Experience has shown that the most consistently accurate results are achieved when the sensors are mounted at 45° with respect to the top of the pipe. In chiller applications, the U1000MKII WM

sensor/electronics must be mounted at 45° with respect to the top of the pipe to prevent condensation entering the electronics unit.

IMPORTANT: DO NOT EXPECT TO OBTAIN ACCURATE RESULTS IF THE SENSORS ARE POSITIONED CLOSE TO ANY OBSTRUCTION THAT DISTORTS THE UNIFORMITY OF THE FLOW PROFILE. MICRONICS LTD ACCEPTS NO RESPONSIBILITY OR LIABILITY IF PRODUCT HAS NOT BEEN INSTALLED IN ACCORDANCE WITH THESE INSTRUCTIONS.

2.1.1 Additional Considerations for Locating Heat Meter versions

For optimum reliability on boiler applications, the flow measurement needs to be made on the cold side of the system. For optimum reliability in chiller applications, the flow measurement needs to be made on the warmer side of the system.

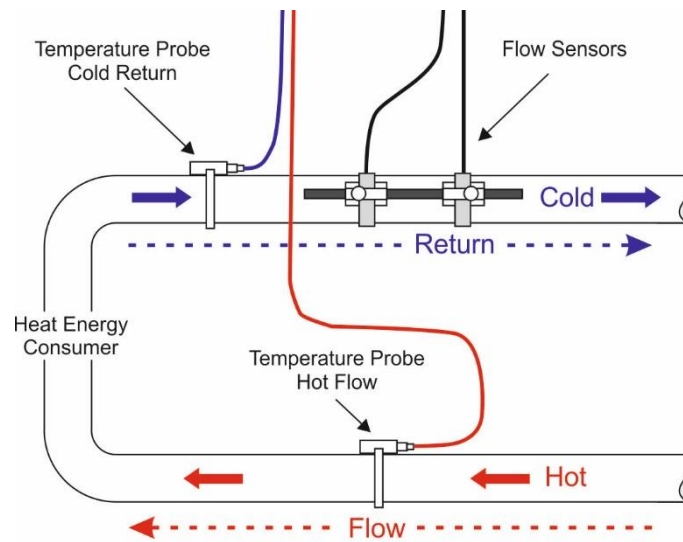

Figure 5: Typical setup of U1000MkII-WM Heat Meter for boiler applications

2.1.2 Clean the Pipe's Flow Sensor Contact Area

Prepare the pipe by degreasing it and removing any loose material or flaking paint to obtain the best possible surface. A smooth contact between pipe surface and the face of the sensors is an important factor in achieving a good ultrasound signal strength and therefore maximum accuracy.

Heat Meter versions: The area of pipe where the temperature sensors are to be attached must be free of grease and any insulating material. It is recommended that any coating on the pipe is removed so that the sensor has the best possible thermal contact with the pipe.

2.2 Connect Power and Signal Cables

This section explains how to connect power and signal cables to the terminal blocks inside the wall mount unit.

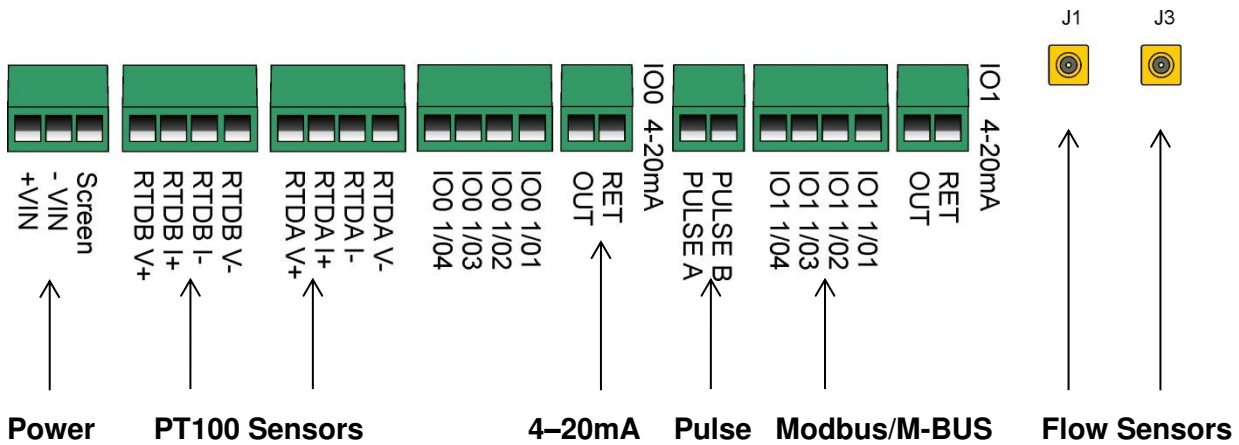

Figure 6: Terminal blocks and connectors

2.2.1 Power Supply

The U1000MKII WM will operate within the voltage range 12–24 VDC or 24 VAC. Micronics can supply, as an optional item, a 24 VAC power supply. If you intend to use an alternative power supply, it must have a minimum rating of 7 VA per instrument. Connect the power supply to the left-hand terminal block labelled +VIN, -VIN and Screen.



EXTERNAL POWER SUPPLY MUST BE CLASS 2 RATED.



IMPORTANT: IT IS THE RESPONSIBILITY OF THE INSTALLER TO CONFORM TO THE REGIONAL VOLTAGE SAFETY DIRECTIVES WHEN CONNECTING THE U1000MKII WM TO A POWER SUPPLY USING A MAINS-RATED TRANSFORMER.

2.2.2 Guiderrail/Flow Sensors

Connect the flow sensors to pins J1 and J3 using the attached 5 m cables.

2.2.3 PT100 Sensors (Heat Meter versions only)

Connect the two PT100 temperature sensors to the terminal blocks labelled RTDA and RTDB using the attached 4-core, 5 m cables, as shown in Figure 7. Do not fasten the probes to the pipework until you have carried out the calibration (see Section 2.8 Calibrate the PT100 Temperature Sensors (Heat Meter versions only)).

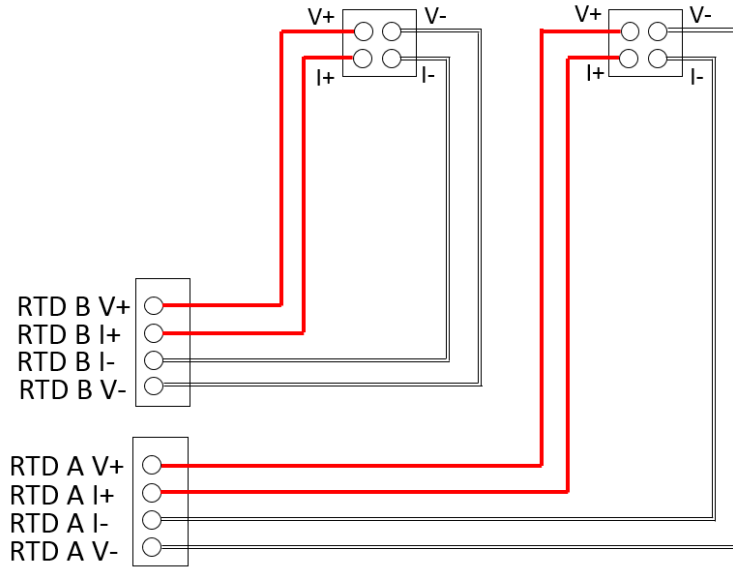

Figure 7: U1000MKII WM Heat Meter PT100 Temperature Probe Wiring

2.2.4 Pulse Output Connection

The isolated pulse output (labelled PULSE-A and PULSE-B) is provided by a SPNO/SPNC MOSFET relay which has a maximum load current of 500 mA and maximum load voltage of 48 VAC.

The relay also provides 2500 V isolation, between the unit's electronics and external equipment.



This output is suitable for SELV circuits only

Electrically this is a Volt, or potential free contact and, when selected as a low flow alarm, is configurable NO/NC.

2.2.5 Current Output (if fitted)

U1000MkII WM unit can be optionally configured with a 4–20mA output. The isolated 4–20mA is a current source and can drive into a maximum load of 600Ω.

If fitted, the 4–20mA current outputs are available at the terminal block labelled IO0 4–20mA with RET and OUT connections. The alarm current due to a flow outside the range specified or due to a loss of signal is set at 3.5 mA.



This output is suitable for SELV circuits only

2.2.6 Modbus/M-Bus Connections (if fitted)

For detailed instructions see the separate manuals

If fitted, the Modbus or M-BUS output is available at the terminal blocks labelled IO1 1/01-04 terminals:

IO1 Terminal	Modbus	M-BUS
IO4	ISOL_GND	ISOL_GND
IO3	OUT_A	BUS1_IN
IO2	ISOL_GND	ISOL_GND
IO1	OUT_B	BUS2_IN

For reliable operation of a Modbus network the cable type and installation must comply with requirements in the Modbus specification document:

“*MODBUS over Serial Line Specification & Implementation guide V1.0*”:

[https://modbus.org/docs/Modbus over serial line V1.pdf](https://modbus.org/docs/Modbus_over_serial_line_V1.pdf)

For full immunity to electrical interference the screen of the power/pulse output cable and Modbus cable should be connected to Earth.

For reliable operation of an M-bus network the cable type and installation must comply with requirements in the M-bus specification document:

“*Meter Communication Twisted Pair Baseband (M-Bus) Physical and Link Layer*”:

<https://m-bus.com/assets/downloads/MBDOC48.PDF>



This output is suitable for SELV circuits only

2.3 Switch On

The initial screen sequence is different for the Flow Meter and Heat Meter models.

The screens shown here are for Metric, the operation for Imperial is the same.

2.3.1 UI000MkII WM Flow Meter

Switch on the power to the Electronics Module. A Micronics start-up screen is displayed for five seconds followed by hardware and software version information.

If Imperial is configured, then the displays will reflect equivalent values and Imperial units.

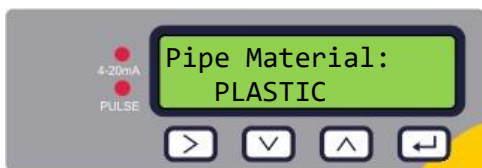

Select the pipe material by using the and keys

to scroll through the list.

Press to confirm the material.

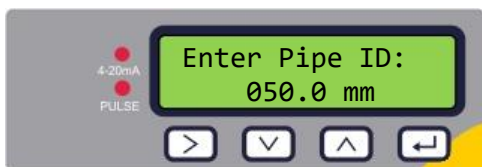

You are then prompted to enter the internal diameter of the pipe:

Use the , , and keys to change the value.

Press to confirm the value.

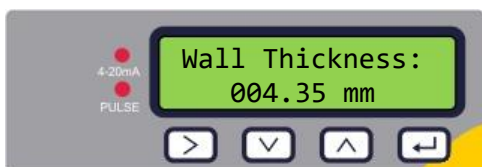

Enter the wall thickness of the pipe:

Use the , , and keys to change the value.

Press to confirm the value.

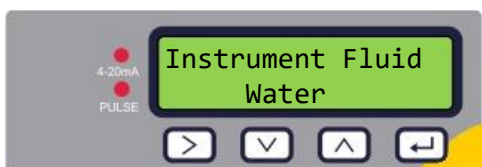

Select the fluid using and . Options are **Water Glycol Ethanol**.

Press to confirm the fluid name.

With **Glycol or Ethanol** Next enter the %age

Either Select the %age of **Ethanol**.

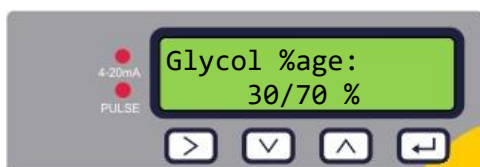
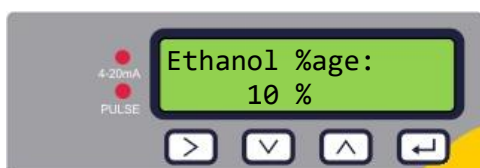

Or Select the %age mix of **Glycol**.



Enter the temperature of the fluid.

Allowed range -20.0–140.0 °C (-4.0–284.0 °F).

Do not set outside the implied fluid ranges.



The unit now shows the correct flow sensor separation (in this case, 12.4 mm) for the chosen values of pipe ID, pipe material and fluid.

Make a note of the separation distance.

All subsequent start-ups will use the same configuration. If the configuration needs to be changed for any reason, use the password-controlled menu (see section 0 If the flow sense here is flipped. Then a reverse flow will change to a positive flow “*”).

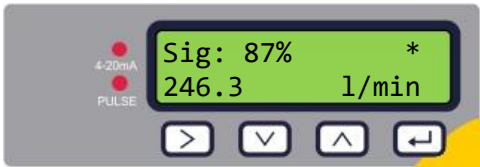

From Main Flow Display press and hold the  then Press the  key. Next Screen Displays.

Menus).



Continue with the installation of the Sensor Assembly (see section 2.4 Assemble the Guiderail).

2.3.2 U1000Mkil WM Heat Meter

Switch on the power to the Electronics Module. A Micronics start-up screen is displayed for 5 seconds followed by hardware and software version information.

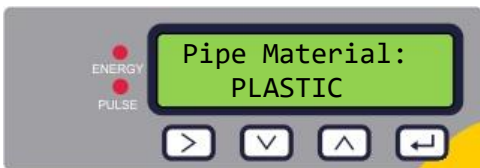
If Imperial is configured, then the displays will reflect equivalent values for Imperial units.



Select the pipe material by using the  and  keys to scroll through the list. Press  to confirm the material.

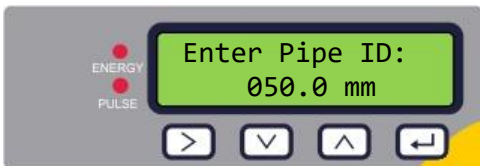

You are then prompted to enter the internal diameter of the pipe:

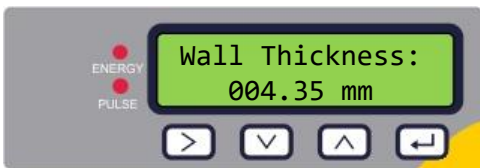

Use the ,  and  keys to change the value. Press  to confirm the value.



Enter the wall thickness of the pipe:

Use the ,  and  keys to change the value. Press  to confirm the value.



Select the fluid using  and . Option are **Water Glycol Ethanol**. Press  to confirm the fluid name.

With **Glycol or Ethanol** Next enter the %age

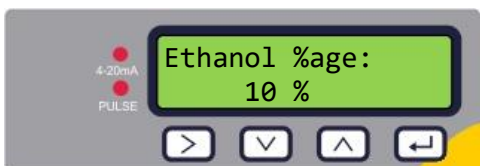

Either Select the %age of **Ethanol**.

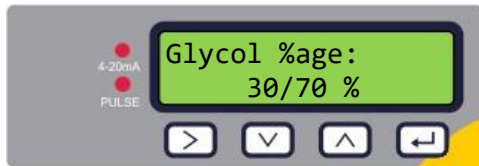



Or Select the %age mix of **Glycol**.



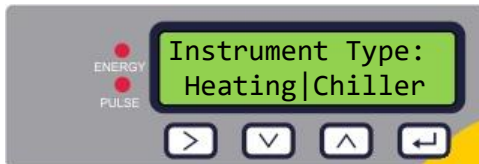

Enter the Fluid temperature

Allowed range:
-20.0–140.0 °C (-4.0–284.0 °F).

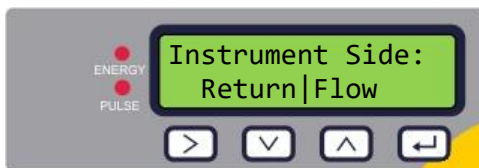

Select the Instrument Type using .
The unit is preconfigured for Heating applications.
Press  to confirm the setting.



Select the Instrument Side (where flow sensors are installed) using .
The unit is preconfigured for *Flow*.
Press  to confirm the setting.



The unit now shows the correct flow sensor separation (in this case, 12.4 mm) for the chosen values of pipe ID, pipe material and fluid.

Make a note of the separation distance.

All subsequent start-ups will use the same configuration. If the configuration needs to be changed for any reason, use the password-controlled menu (see section 3.2).

Continue with the installation of the Sensor Assembly (see section 2.4 Assemble the Guiderail).

2.4 Assemble the Guiderail

Slide the guiderail through the slot on the top of the two transducers.

2.5 Adjust Flow Sensor Separation

Using the separation distance displayed by the control unit (see 2.3 Switch On), adjust the transducer separation accordingly. Fasten the sensors to the correct position on the guiderail using the thumbscrews.

2.6 Apply Gel Pads

1. Apply a gel pad centrally onto the bases of each of the two flow transducers.
2. Remove the covers from the gel pads.
3. Ensure there are no air bubbles between each pad and sensor base.

2.7 Clamp Guiderail to Pipe

Ensure that you have selected a suitable location and that the pipe is clean (see section 2 Installation).

Using the quick-release clamps provided, fasten the transducers to the pipe at an angle of 45° as shown in Figure 8. Experience has shown that the most consistently accurate results are achieved when the unit is mounted at this angle (see 2.1 Positioning). This minimises the effect of any flow turbulence resulting from entrained air along the top of the pipe and sludge at the bottom.

2.8 Calibrate the PT100 Temperature Sensors (Heat Meter versions only)

IMPORTANT: THE PT100 SENSORS MUST BE BALANCED BEFORE INITIAL USE, USING THE PROCEDURE DESCRIBED BELOW AND USED WITH THE CABLE LENGTH SUPPLIED. EXTENDING OR SHORTENING THE CABLES WILL NEGATE THE CALIBRATION OF THE SENSORS.

To ensure an accurate temperature differential:

1. Place the PT100 sensors touching each other and allow their temperature to stabilise for 1 minute.
2. Enter the password-controlled menu and scroll to the *Calibration* sub-menu (see Section 3.7 Calibration Menu).
3. Press the Enter key until the *Zero Temp Offset* screen is displayed.
4. Select **Yes** and press the Enter key to display the *Attach Sensors* screen.
5. Press the Enter key again and wait for instrument to return to the *Zero Temp Offset* screen.

2.9 Attach the PT100 Sensors (Heat Meter versions only)

The PT100 sensors must be located at the input and output of the system that is being monitored. The area of pipe where they are to be attached must be free of grease and any insulating material. It is recommended that any coating on the pipe is removed so that the sensor has the best possible thermal contact with the pipe.

Clamp the sensors in position using the supplied stainless-steel cable ties.



Figure 8: Fully assembled U1000MkII-WM Heat Meter unit

2.10 Zero offset the Flow Sensors

For low flow rates slight offsets in the sensors/electronics can interfere with the accuracy of the measurements. It is advisable to zero-offset the sensors once they are in place, if they are moved, or if a new unit is attached.

Refer to menus section 3.7: Calibration and summary below.

The pipe should have Fluid present but with no Flow. If this is not possible (no access to valves or Company will not allow) then leave this unset.

See Section 3.1 Accessing the Menus.

Enter the

User Menu (password) -> Calibration

Step to the Zero-Offset Screen then

Set a new Zero-Offset	<input type="checkbox"/>
Accept Setting and Carry On	<input type="checkbox"/>

2.11 Normal Operation

The screen sequence is different for the Flow Meter and Heat Meter models.

2.11.1 UI000MkII-WM Flow Meter

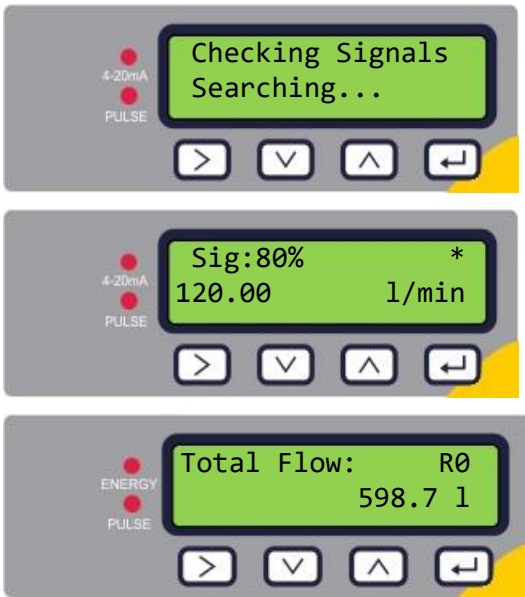

The unit checks for a valid flow signal.

If a valid signal is found, signal strength and flow rate are displayed. The signal strength should be at least 40% for reliable operation.

Press the  and  keys to scroll to the Total Flow and back to the main Flow Screen.

2.11.2 UI000MkII-WM Heat Meter

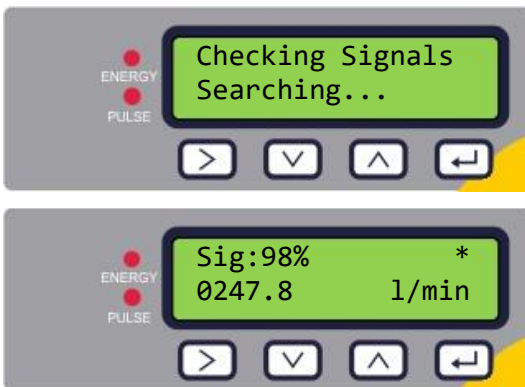

The unit checks for a valid flow signal.

If a valid signal is found, signal strength and flow rate are displayed. The signal strength should be at least 40% for reliable operation.

Press the  and  keys to scroll to the Total Flow, Temperature (Hot Cold dT), Total Energy and instant Power screens.

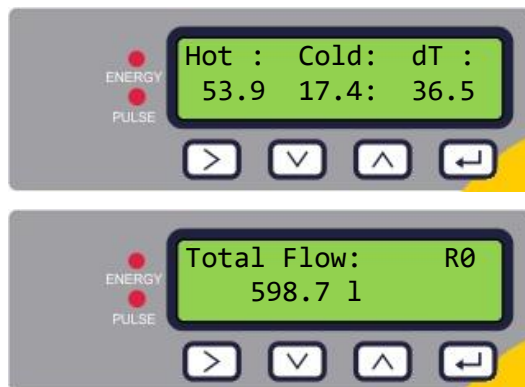
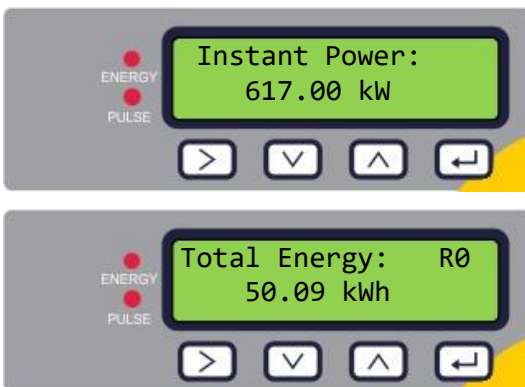

Note: The "R0/Rx" Value on the totals screens represents the number of Rollovers that have occurred since a reset (1 digit only is displayed). See the Rollover Section for further information.

2.12 Totals and Rollover

The actual Totals (Volume and Energy) have a finite range. Think of a mechanical counter with say 6 digits, this will cycle back to “000000” after “999999”. So, when it hits the limit, or ‘Rollover Value’, the counter/value will reset to 0.0.

The Rx number (R0 here) on the first line indicates how many Rollovers (x) have occurred since the unit was reset. This is only accurate to 1 digit and is deemed adequate. Management/Monitoring Systems will normally detect a rollover event and act accordingly.

The Rollover Value is determined by the Totals number Format and Size, which in turn can be a fixed requirement of the Comms Method (typically M-Bus and BACnet have requirements) or the Management/Monitoring System (BEMS system or aM&T etc). See section 3.8.1.

The Number Format size is set in the Volume Menu in the User Options. The first option here just allows you to reset the Volume value. The second option allows you to set the number size/format. Number Options and corresponding Rollover values are:

Number Format	Rollover Value
Float	9999999
Int 32	999999999
Int 48	9999999999
Int 64	99999999999

The Energy Total uses the same values.

The Rollover value is equivalent to the User Units in use:

Volume - litres,m³,USGal, ImpGal, ft³.

Energy - kWh or kBTU.

NOTE: Setting this value incorrectly can result in the Monitoring system unable to read the totals.

NOTE: Float is most common and has been used extensively before this option was introduced and should be used as a default if no other information is available.

2.13 Troubleshooting the Flow Reading

The direction of flow is determined when the meter is first powered up from Reset and is taken to be the positive flow direction. It is possible this can get set incorrectly if there is back wash or no flow when installing/commissioning.

The direction of flow is reset by stepping through the Setup Menu (no need to change any values). On exit to the main flow screen the direction will be re-determined. So naturally any changes to the Setup will cause the Flow Direction to be reset.

Alternatively, the Positive Flow Direction can be flipped, from the Front Panel, by pressing and Holding the DOWN Key then pressing the UP Key, see section 2.14.

If the flow is reversed, then the flow rate will still be displayed but the activity indication will change from an asterisk to an exclamation mark. This helps assess if the system is working and if there is a reverse flow present.

The pulse output is related to the flow in this positive direction, so no pulses will be generated if the flow is reversed.

With flow reversed no totals are accumulated, both volume and energy; no Power is displayed. Comms Ports may indicate the Flow Rate, as this is useful to a remote operator.

If the flow rate is very low then the flow zero-offset should be set. This requires the flow to be stopped but have fluid in the pipe see section 3.7 Calibration.

If the flow value is displayed as “-----” there is no usable signal from the flow sensors.

Some causes of signal drop are:

- Incorrect pipe data / Separation Distance; Recheck the Setup and sensor placement. Run through the User Setup menu.
- Sensor not in contact with the pipe, fix
- Air in the liquid/pipe, try and adjust the placing of the sensors see section [2.1 Positioning](#)
- No Gel pad or grease on the sensor See Section [2 Installation](#).
- Very poor pipe condition on the surface or internal, move sensors to a new location and re-try.

2.14 Resetting the Flow Direction

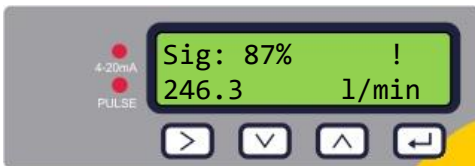

Applicable to HM and FM. This may not be present on all versions.

Starting with a reversed flow, see the “!” is present.

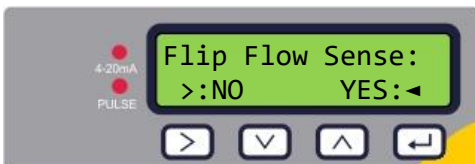

From Main Flow Display press and hold the  then Press the  key. Next Screen Displays.



Press  to Flip the Flow Sense, if it is incorrectly reversed or  to escape back to the Main Flow Screen.

If the flow sense here is flipped. Then a reverse flow will change to a positive flow “*”.

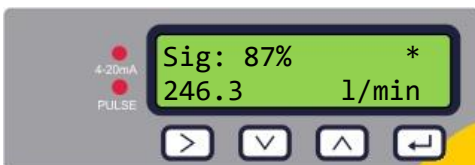

From Main Flow Display press and hold the  then Press the  key. Next Screen Displays.

3 MENUS

The password-protected menus allow you to change the default settings:

- Setup (see Section 3.2 Setup Menu)
- Current Output (see Section 3.3 Current Output Menu)
- Modbus (see Section 3.4 Modbus Setup Menu)
- M-Bus (see Section 3.5 M-Bus Setup Menu)
- Pulse Output (see Section 3.6 Pulse Output Menu)
- Calibration (see Section 3.7 Calibration Menu)
- Volume Totals (see Section 3.8 Volume Totals Menu)
- Exit

For troubleshooting purposes, an additional Diagnostics menu is available from the main *Flow Reading* or *Total Flows* screens (see 3.9 Diagnostics Menu).

3.1 Accessing the Menus

Ensure that the instrument Display is showing Flow Reading, Total Flow, Temperature dT, Total Energy or Instant Power then press .

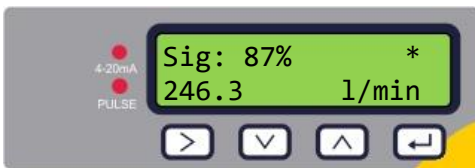



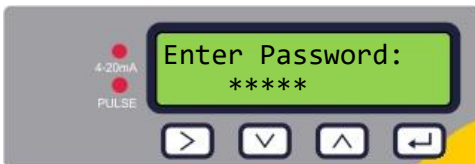

From Main Flow Displays press .





Enter 71360 and then press .



The Setup Menu is displayed.

Use  and  to cycle through the various Menu Sections (number depends on unit configuration). Press  to enter a menu. To return to the Flow Reading screen, scroll down to **Exit** and press .

Within a menu, press  to change between two displayed options (the active setting flashes) or, if there are several options, use  and  to cycle through the possible values.

Press  to confirm a value and display the next setting (or exit the menu if it is the last option).

3.2 Setup Menu

Setup the U1000 Pipe, Fluid, and configuration information for the intended use.



With the Setup menu selected in the User Menu press  and step through the menus in section 3.2.1 3.2.5 where the separation distance will be shown.

3.2.1 Pipe Characteristics

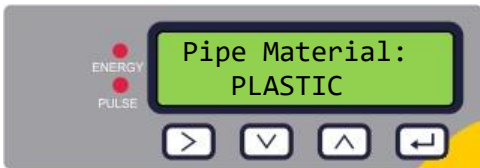

Choose whether to use imperial or metric units (default). If “inches” option is selected, the temperatures will be displayed in °F and the energy values will be in kBTUs. The following diagrams show the metric options only.



Select the pipe material by using the  and  keys to scroll through the list.

Press  to confirm the material and continue.

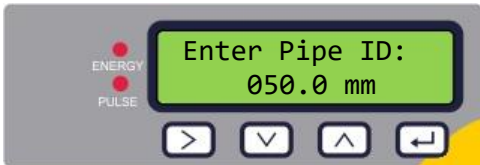

You are then prompted to enter the internal diameter of the pipe:

Use the ,  and  keys to change the value.

Press  to confirm the value. Depending on configuration of the unit, valid values are in the range:

20–110 mm (0.787–4.33 inches) or

100–220 mm (3.94–8.66 inches).

Enter the wall thickness of the pipe:

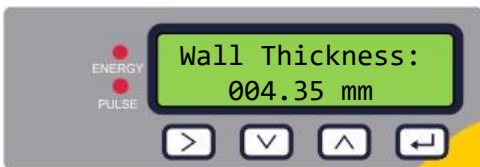

Use the ,  and  keys to change the value.

Press  to confirm the value and continue.



3.2.2 Fluid Characteristics





Select the Fluid Type using  and  from: **Water, Glycol, Ethanol.**

Press  to Select to Continue.

Note: Water, naturally does not have a concentration. If either Glycol or Ethanol are selected the Concentration Menu will show else proceed to System Units.

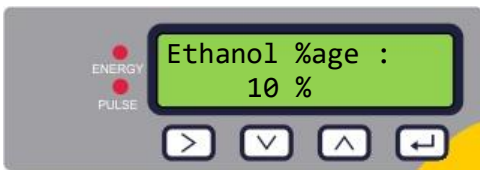
3.2.2.1 Ethanol Concentration



Select the Fluid Composition using  and  from:



10, 20, 30, 40, 50 %, of Ethanol in Water.

Press  to Select and go to either a Concentration Menu or Proceed with Setup.

Note: Options here may change.

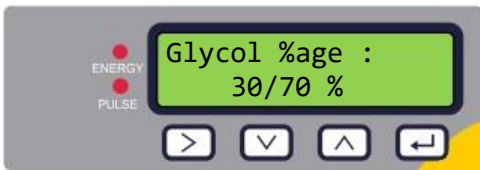
3.2.2.1 Glycol Concentration



Select the Fluid Composition using  and  from:

30/70, 35/65, 40/60, 50/50 %, Glycol/Water Mix.

Press  to Select and go to either a Concentration Menu or Proceed with Setup.

Note: Options here may change

3.2.3 System Units

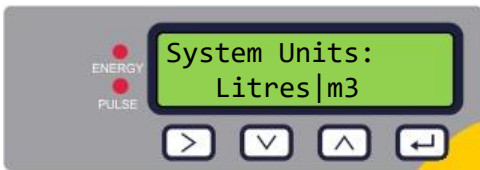

Choose the **System Units**. If you selected **mm** in the first step (*Select Dim*), the choice is **litres** or **m³**. If you selected **Inches**, the choice is Imperial gallons or US gallons.

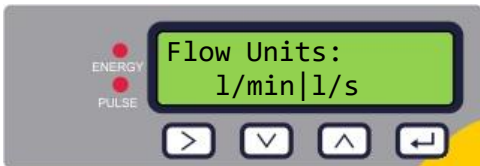



Choose the **Flow Units**. If you selected **mm** in the first step (*Select Dims*), the choice is l/min or l/s. If you selected **Inches**, the choice is gal/min or gal/hr (with either Imperial or US gallons according to the *System Units* selection).

3.2.4 Instrument Configuration





Heat Meters only

Select the instrument setting using . The unit is preconfigured for **Heating** applications. Press  to confirm the setting and proceed.



Heat Meters only

Select the Instrument Side using  (where flow sensors are installed). The unit is preconfigured for **Flow**. Press  to confirm the setting and Finalize the Setup.

3.2.5 Separation Distance



This is for information only.

The unit now shows the correct flow sensor separation (in this case, “**12.4 mm**”) for the chosen values of pipe ID, pipe material and fluid.

Make a note of this **Separation** Distance it is needed when fitting the sensors.

Press  to return to the User Menu.

3.3 Current Output Menu

If the 4–20mA option is fitted enter this menu from the user menu to set up the Current Output.

The equivalent flow at the full scale of 20 mA is set then the flow at 4 mA is set. The latter is normally zero. Flow Values in between these two limits are scaled to give the equivalent Current Output.

Also See Section 4.2 4–20mA Output.

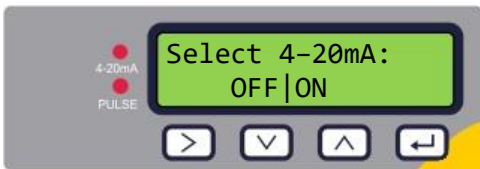

Enable or disable the 4–20mA output using  to select OFF or ON.

Press  to confirm the setting.

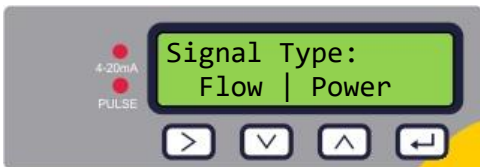

Select the signal Source / Type , Active is flashing

Press  to confirm.

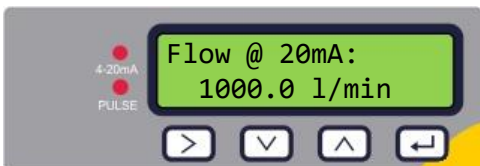

If enabled (**ON**) else return to User Menu

Enter the maximum flow, equivalent to 20 mA.

Press  to confirm.



Enter the minimum flow, will equivalent to 4 mA.

Usually this is 0.00 user units (**l/min** here)

Press  to confirm and return to the User Menu.

3.4 Modbus Setup Menu

If the Modbus Option is configured then the serial connection is configured here.

See the U1000 Modbus Manual for more details.



Enter the Modbus Address for this unit. The valid range is **001** to **126**.

Press  to confirm the setting.

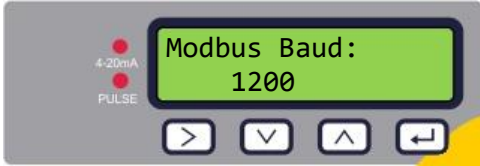

Enter the baud rate for the Modbus network. Valid settings are **1200, 2400, 4800, 9600, 19200, or 38400**.

Press  to confirm.

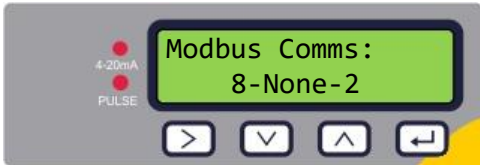

Select the Modbus data format. Valid settings are: **8-None-2, 8-Even-1, 8-Odd-1, 8-None-1**.

The settings determine the data bits in each character (8), the parity (Odd, Even or none), and the number of stop bits (1 or 2).

Press  to confirm and return to the User Menu.

NOTE: This setup needs to match the Master / Receiving equipment setup.

3.5 M-Bus Setup Menu

If the M-Bus option is configured then set up the M-Bus Characteristics here.

See the M-U100 Bus Manual for further details.

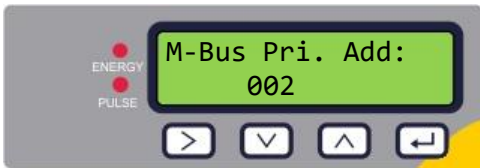

Enter the M-Bus Primary Address for this unit. The valid range is **001** to **250**.

Press  to confirm the setting.

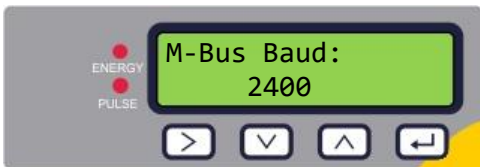

Enter the M-Bus Baud rate for this unit. The valid options are **300, 2400 or 9600** Baud.

Press  to confirm the setting.

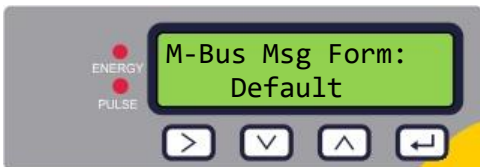

Enter the M-Bus Telegram Format. As:

“Default” or “Msg Format 1”

These are the Message Formats the controller/Master is expecting. See the M-Bus Manual for a full description.

Press  to confirm the setting and return to User Menu.

NOTE: Default returns Float types for the measured data in the M-Bus Telegram, **“Msg Format 1”** replaces the Floats with 32 bit Integers and with a minimal number of measured values. At commissioning this needs to be understood as some Controllers/Hubs require a specific setting, whilst others accept either. The options here will increase with time/requirements.

NOTE: If in doubt leave at the **Default** setting. This is general setting that will suite most interfaces.

NOTE: This affects the Volume Totals settings and the Rollover value as well. See section on Rollover.

3.6 Pulse Output Menu

All models allow the use of a pulse output based on Volume pulse, Alarm, Energy pulse (Heat Meter versions only) or Frequency indicating flow rate.

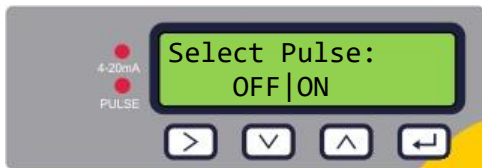

Enable or Disable the Pulse output using  to select **OFF** or **ON**.

Press  to confirm the setting.

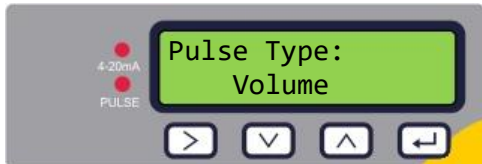

Choose the Pulse type:

Volume, Flow Alarm, Energy, Frequency.

Press  to confirm and move to the relevant Menu or back to the User Menu.

NOTE: Energy is for Heat Meter versions only. See next sections for the setup of each option.

3.6.1 Volume Pulse

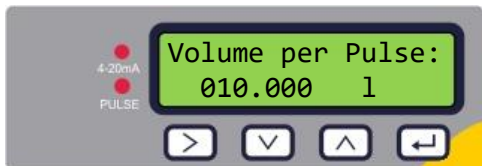

Set the Volume per Pulse so that the maximum number of pulses does not exceed 10 per second or 1000ms (see 4.1.1 Volumetric Pulse).

Press  to confirm the setting.

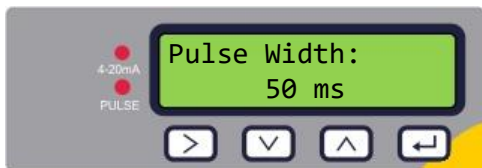

Set the Pulse Width. The default value is **50 ms** which represents one half of a pulse cycle. A **50 ms** pulse width is required for most mechanical counters.

Press  to confirm the setting and return to the User Menu.

3.6.2 Flow Alarm



Choose the type of alarm : **Level**, triggering at a lowest acceptable flow rate, or **Signal Loss**, indicating a loss or malfunction of flow or signal.

Press  to confirm the setting.

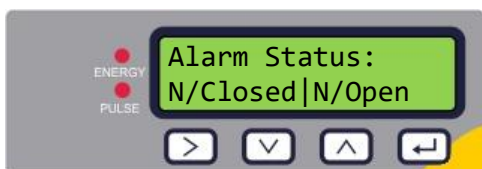

Select the status of the pulse output during normal operation : **Normally Closed** or **Normally Open**.

Press  to confirm the setting.



Displayed if **Level** Type alarm type has been selected. Enter the flow value required to trigger the alarm.

Press  to confirm the setting and move back to the User Menu.

See section 4.1.4 Alarm.

3.6.3 Energy Pulse (Heat Meter versions only)

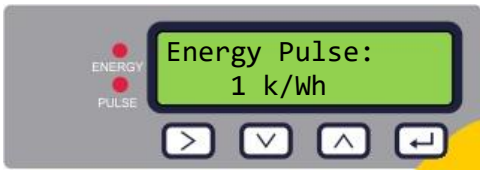

Choose from **1,10,100 kWh or 1 MWh** when in metric mode and **1,10,100 kBTU or 1 MBTU** in imperial mode. Each pulse represents the selected amount of energy e.g., 1 kWh. Choose a value so that the pulse rate does not exceed 10 per second (see 4.1.3 Energy Pulse).

Press  to confirm the setting.

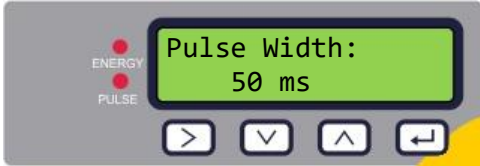

Set the Pulse Width. The default value is **50 ms** which represents half of one pulse cycle. A 50ms pulse width is required for most mechanical counters.

Press  to confirm the setting and move back to the User Menu.

See section [4.1.3 Energy Pulse](#).

3.6.4 Frequency

In Frequency mode, the pulse output frequency is proportional to the flow rate within a specified frequency range of 1 – 200 Hz.

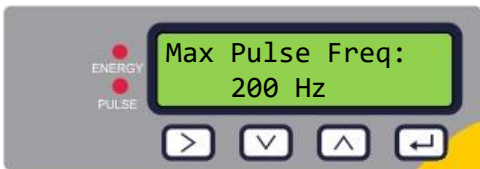

Choose the Maximum Pulse Frequency. The valid range is **1.0 – 200.0 Hz**.

Press  to confirm the setting.



Enter the maximum flow rate at the specified frequency. **The flow units are fixed as litres per second.**

Press  to confirm the setting and move back to the User Menu.

See section [4.1.2 Frequency Mode](#).

3.7 Calibration Menu



Choose a Damping Time of **10, 20, 30, 50 or 100 s**.

Press  to confirm the setting.

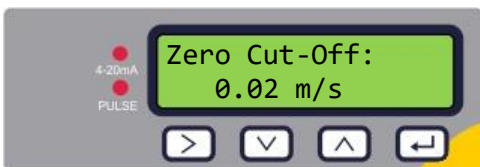

Set the Zero Cut-Off value (in the range **0.00–0.50 m/s**).

Press  to confirm the setting.

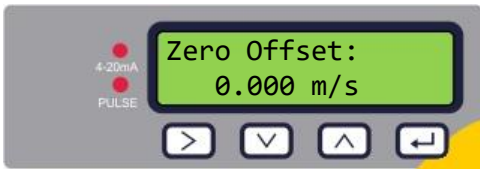

Press to calculate the Zero Offset automatically.

Press to Clear the Zero Offset to 0.00 m/s.

Press to confirm the setting.

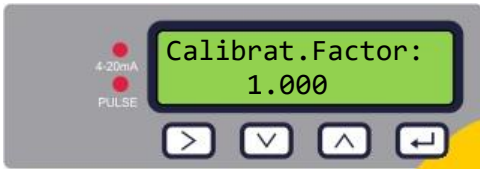

Enter a calibration factor (valid range **0.500–1.500**).

Press to confirm the setting and, in the case of Flow Meter versions, return to the Main Menu.

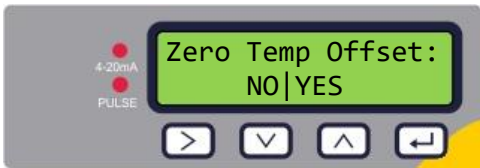

Heat Meter versions only.

Use to select **YES** to calculate the Zero Temperature Offset value. Select **NO** to return to the Main Menu.



You are prompted to attach the sensors. Place the PT100 sensors touching each other and allow their temperature to stabilise for 3 minutes.

Press to continue.

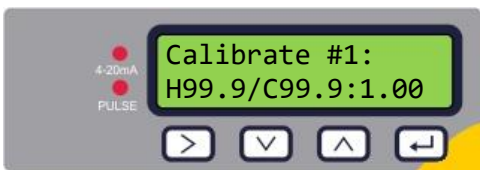

The unit calculates the temperature offset.

When the procedure is complete, the **Zero Temp Offset** screen is displayed with NO selected.

Press to return to the Main Menu.

3.8 Volume Totals Menu

3.8.1 Volume Totals Reset

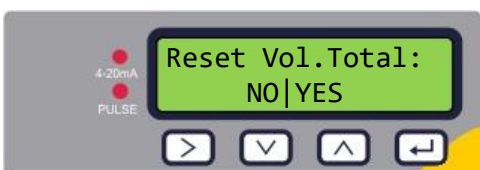

To zero the Volume Totals value, select Yes .

Press to confirm which action and return to continue to the Totals Format Menu.

3.8.2 Totals Format Type





Use and to select the Totals Number Format. This is either **Float** or one of integer type: **Int 32, Int 48, Int 64**.

Press to confirm the action and return to the User Menu.

Note: The rollover point is also fixed from this setting as the maximum value the Totals can reach see section 2.12 Totals and Rollover.

3.9 Diagnostics Menu

The diagnostics menu provides some additional information about the flowmeter and its setup. The Menu can be accessed by pressing the  key from the main flow-reading screen. Press the  and  keys to move between the diagnostics screens.

Press  to exit the Diagnostics menu.

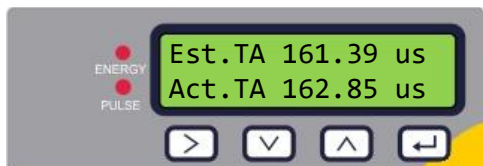

The Estimated TA (Time of Arrival) and Actual TA show the theoretical and measured transit times. If the actual value is displayed as 9999.99 then there is no usable signal detected.



Displays the pulse status (for example):

Deactivated, Volume 0.000 litres, **Signal Loss, Alarm(On)** 500.0 l/min, **Alarm(Off) Signal Loss, Frequency** 100.00 Hz.

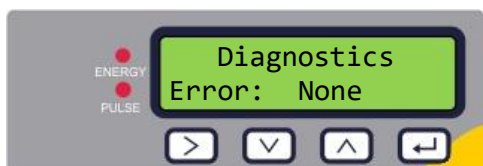

A number between 1 and 256 will be displayed. If no errors reported "None" is displayed. See Section 5.2.1 on how to interpret this.

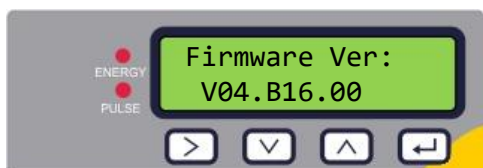

Shows the Current Firmware (Software) Version

04.16.00 – as this changes new features and operation will be added.



The RTD board's firmware version is shown on the lower line. The upper line shows its status.



The flow board's firmware version is shown on the lower line. The upper line shows its status.

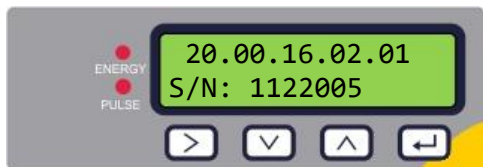

The unit's firmware version is shown on the upper line. The lower line shows the unit's serial number.

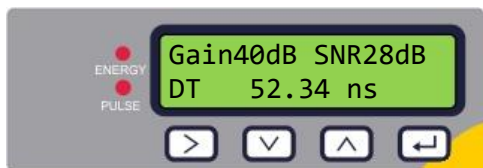

Gain – decibels -5dB and 80dB – *lower is better*, should be around 40dB or below. Above 60dB question the installation. **SNR** (Signal/Noise ratio) in dB, scale is 0 to 80dB – *higher is better*. Below 20, question the installation.

DT the time difference between upstream and downstream signals. Proportionate to the Flow Velocity.

4 OUTPUTS

4.1 Pulse Output

Pulse Out is an Electronic Isolated Relay (see section 2.2.4 Pulse Output Connection), with NO/NC options where applicable. As such it does not strictly supply a Pulse, it is up to the Controller to detect the Relay State.

The Pulse output will operate in one of five modes (see 3.6 Pulse Output Menu):

- Volumetric flow total
- Energy (Heat Meter versions only)
- Frequency
- Low Flow Alarm
- Loss of Flow Signal Alarm

The Alarm functions allow you to set the alarm switch to *Normally Open* or *Normally Closed*.

4.1.1 Volumetric Pulse

The U1000MKII WM default pulse width is set to 50 ms which represents half of one pulse cycle. A 50ms pulse width is required for most mechanical counters. 50 ms equates to a 100 ms cycle or 10 pulses per second.

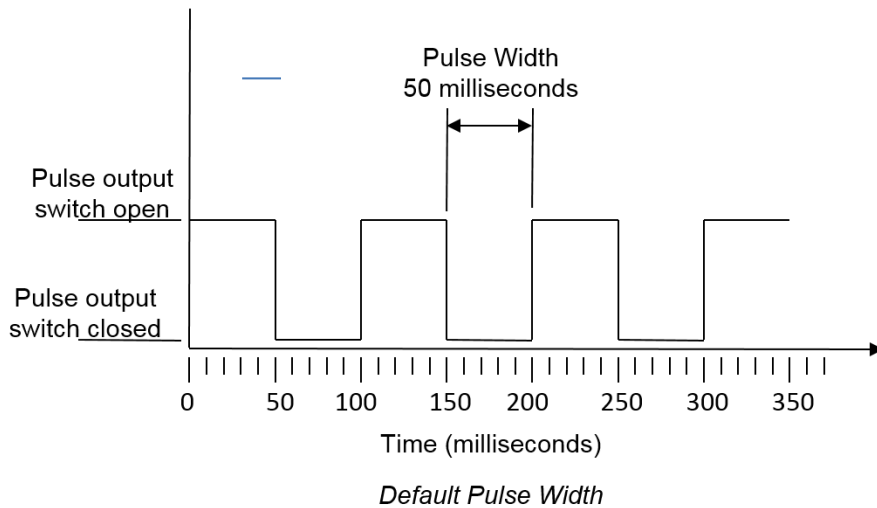

Figure 9: Volume / Energy Pulse Width

Formula to obtain Volume per Pulse based on a (default) 50 ms pulse width:

Volume per Pulse \geq maximum flow rate (in litres per minute) / 600

Example for maximum flow rate of 500 l/min:

Volume per Pulse \geq 500 l/min / 600 = 0.833 litres per pulse (600 = 60 sec * 10 pulses)

Or Same Calculation:

500 l/min equivalent to 8.33 l/sec,

Volume per Pulse \geq 8.33 l/s / 10 pulses/sec = 0.833 litres per pulse

Rounding up to nearest whole litre:

Set **Volume per Pulse** to **1 litre**.

NOTE: Pulses are accumulated, and carried over, if more than the allowed number per second are generated **But This Should be Avoided** as Pulses can be lost if the situation persists for too long. Further, the pulses will continue for some time after the flow has stopped/decreased, to give an accurate total flow value. The volume per pulse should be increased in this case, then there is no overall loss of accuracy wrt the Totals values. Alternatively, the pulse width can be decreased to increase the pulses / second. Care is needed here if the equipment receiving the pulses cannot cope with the new pulse width.

4.1.2 Frequency Mode

In Frequency mode, the output frequency is proportional to the flow rate within a specified frequency range of 1–200 Hz.

NOTE: The flow units are fixed as litres per second.

4.1.3 Energy Pulse

With the Heat Meter version, when the Pulse Output is set to Energy, the kWh LED will be permanently illuminated. Choose from 1,10,100 kWh or 1 MWh when in metric mode and 1,10,100 kBTU or 1 MBTU in imperial mode. Each pulse represents an amount of energy e.g., 1 kWh. The same limitation on maximum pulse rate applies as detailed in the Volumetric Mode. Again, a larger unit of energy per pulse or a smaller pulse width may be required.

4.1.4 Alarm

Alarm Conditions.

4.1.4.1 Low Flow

For the Low Alarm the user can set a range between 0 and 9999 (no decimal places), in the same units being used to measure flow. The default setting is normally open, but the user can select between N/O and N/C. There is a 2.5% hysteresis on the switching of the output. Once the low flow alarm is activated, the flow rate must rise by 2.5% more than the set value to deactivate the alarm again.

4.1.4.2 Signal Loss

If the flow reading (signal) is lost, as indicated by the flow rate being displayed as “----”, the alarm will be triggered. The default setting is normally open, but the user can select between N/O and N/C.

4.2 4–20mA Current Output - Optional

The default 4–20mA output setting is OFF, and the 4–20mA LED on the keypad will not be illuminated. The default flow for 20 mA output will be automatically set to a default value of

Flow	1000 l/m
Energy	200 MW

Figure 10: Default 4–20mA values

The default flow for 4 mA is 0.0 units. This can be changed, see 3.3 Current Output Menu , but is usually set to 0.0 units.

If the flow reading is greater than that set as the 20 mA value, or there is negative flow, or no flow signal can be detected, then an alarm current of 3.5 mA will be generated.

NOTE: The 4–20mA current output is factory calibrated.

4.3 Modbus - Optional

See the separate manual “U1000 Modbus” from the Micronics website.

4.4 M-Bus - Optional

See the separate document “U1000 M-Bus” from the Micronics website.

5 DEFAULT VALUES AND ERROR CODES

5.1 Defaults

The settings will be configured at the factory for metric units. The following table lists the metric and imperial default values.

Parameter	Default Value	
	Metric	Imperial
Dimensions	mm	inches
Flow Units	l/min	USGal/min
Pipe size (ID)	1" to 4" pipes: 50 mm 4" to 8" pipes: 127 mm	1" to 4" pipes: 1.969 in 4" to 8" pipes: 5.000 in
Pulse Output	Off	Off
Energy per Pulse <i>(Heat Meter versions only)</i>	1kW	1kBTU
Volume per Pulse	10 litres	2.642 US gallons
Pulse Width	50 ms	50 ms
Damping	20 seconds	20 seconds
Calibration Factor	1.000	1.000
Zero Cut-off	0.02 m/s	0.07 ft/s
Zero Offset	0.000 m/s	0.000 ft/s

5.2 Error and Warning Messages

5.2.1 Error Messages

Error Messages are displayed as a number in the diagnostics menu. Contact Micronics if other messages appear.

Error Meaning	Status Byte								Value
	Bit#7	Bit#6	Bit#5	Bit#4	Bit#3	Bit#2	Bit#1	Bit#0	
RTD Comms failed								1	1
RTD T _{hot} failed							1		2
RTD T _{cold} failed						1			4
TOFM signal lost					1				8
TOFM board failed				1					16
TOFM window failed			1						32
TOFM sensor type failed		1							64
TOFM I2C failed	1								128

RTD on Heat Meter versions only.

5.2.2 Example Error Messages

Error Message	Error Meaning
None or 0	None
2	Hot sensor error (<i>Heat Meter versions only</i>)
4	Cold sensor error (<i>Heat Meter versions only</i>)
6	Hot and Cold sensor error (<i>Heat Meter versions only</i>)
8	No flow signal
10	Hot error and no flow signal (<i>Heat Meter versions only</i>)
12	Cold error and no flow signal (<i>Heat Meter versions only</i>)
14	Hot and Cold error and no flow signal (<i>Heat Meter versions only</i>)

5.2.3 Modbus Error Messages (if Modbus fitted)

Test case	Transmitter							
	Address	Command	Start Register		Length (no of registers)		CRC-16	
	[1 byte]	[1 byte]	[2 bytes]		[2 bytes]		[2 bytes]	
No error	0x01	0x03	0x00	0x00	0x00	0x20	0x44	0x12
Incorrect function request	0x01	0x0C	0x00	0x00	0x00	0x20	0x10	0x13
Incorrect register start	0x01	0x03	0x00	0xEF	0x00	0x20	0x75	0xE7
Incorrect register length	0x01	0x03	0x00	0x12	0xFF	0x02	0x25	0xFE
Slave is busy	0x01	0x03	0x00	0x00	0x00	0x20	0x44	0x12
Incorrect CRC-16	0x01	0x03	0x00	0x20	0x00	0x20	0x44	0xFF

Receiver					Comments
Address	Command	Error code	CRC-16		
[1 byte]	[1 byte]	[1 byte]	[2 bytes]		
0x01	0x03	None	n/a	n/a	Example of a good message
0x01	0x8C	0x01	0x85	0x00	ILLEGAL FUNCTION - the only acceptable command is 0x03
0x01	0x83	0x02	0xC0	0xF1	ILLEGAL DATA ADDRESS - incorrect register start
0x01	0x83	0x03	0x01	0x31	ILLEGAL DATA VALUE - incorrect register length
0x01	0x83	0x06	0xC1	0x32	SLAVE DEVICE BUSY – U1000MkII WM is busy processing and is unable to respond
0x01	0x83	0x07	0x00	0xF2	CRC is incorrect

5.2.4 Flow Errors

A signal strength of less than 40% indicates poor set up of the instrument, and the installation should be checked or possibly moved to a different site.

5.2.5 Flow Warnings

A signal strength of less than 40% indicates poor set up of the instrument, and the installation should be checked or possibly moved to a different site. A negative flow is indicated by an "!" being displayed on the top line instead of a "*" .

5.2.6 Data Entry Errors

These generally advise you that the data entered is not within the specified range:

Range 20.0 – 215.0
0.000 mm

Displayed when an invalid Pipe ID is entered, prompting the user to enter a value between 20 and 215 mm depending on the product purchased.

Calibrate Error
Press Enter

An attempt has been made to zero the offset between the temperature sensors, and the difference in temperature is too large. Ensure the temperature sensors are correctly plugged in and are both at the same temperature.

Range 1 - 200
200

When programming a Frequency Pulse output the frequency is limited to the range 1 to 200 Hz.

Range 3 - 99
0000.0

When programming a Volume Pulse output the pulse width is limited to the range 3 to 99 ms.

Range 0.00 – 0.500
0000.0

When programming the Zero Cut-off this is limited to the range 0.000 to 0.500.

Range 0.500 – 1.500
0000.0

When programming the Calibration Factor this is limited to the range 0.5 to 1.5.

6 APPENDIX

6.1 Specification

General	
Measuring Technique	Transit time
Measurement channels	1
Timing Resolution	±50 ps
Turndown ratio	100:1
Flow velocity range	0.1 to 10m/s
Applicable Fluid types	Clean water with < 3% by volume of particulate content, or up to 30% ethylene glycol.
Accuracy	±3% of flow reading for velocity rate >0.3 m/s
Repeatability	±0.15% of measured value
Pipe Ranges	25–115 mm OD and 125–225 mm OD (1" to 4" and 4" to 8", nominally) Note: Pipe size is dependent on pipe material and internal diameter.
Selectable units for metric (mm)	Velocity: m/s. Flow Rate: l/s, l/min, m ³ /min, m ³ /h. Volume: litres, m ³ .
Selectable units for Imperial (inches)	Velocity: ft/s Flow rate: gal/min, gal/hr, USGal/min, USGal/h Volume: gal, USGal
Totaliser	Variable digits with roll over to zero see section 2.12 on Rollover
Languages supported	English only
Power input	12–24 Vdc or 24 Vac
Power consumption	7 W (DC) or 7 VA (AC) maximum
Pulse Output	
Output	Opto-isolated MOSFET volt free contact (NO/NC).
Isolation	1MΩ @ 100 V
Pulse width	3–99 ms
Pulse repetition rate	Up to 166 pulses/sec (depending on pulse width > 3 ms)
Frequency mode	200 Hz maximum (Range 1–200)
Maximum load voltage/current	24V DC or 24V AC / 500mA
Current Output	
Output	4 to 20 mA
Resolution	0.1% of full scale
Maximum load	600Ω
Isolation	1MΩ @ 100V AC/DC
Alarm current	3.5 mA
Modbus (if fitted)	
Format	RTU
Baud rate	1200, 2400, 4800, 9600, 19200, 38400
Data -Parity-Stop Bits	8-None-2, 8-None-1, 8-Odd-2, 8-Even-1

continued next page

Modbus (if fitted) – continued	
Standards	PI-MBUS-300 Rev. J
Physical connection	RS485
Isolation	1 MΩ @ 100 V AC/DC
M-Bus (if fitted)	
Baud rate	300, 2400, 9600
Data -Parity-Stop Bits	8-Even-1
Standards	EN13757 / EN1434
Isolation	1 MΩ @ 100V AC/DC
Temperature Sensors (Heat Meter Only)	
Type	PT100 Class B 4 Wire
Range	-20.0 to 140 °C (-4 to 284 °F)
Resolution	0.1 °C (1 °F)
Flammability Rating	±0.725 °C (±1.305 °F)
Enclosure	
Material	Plastic Polycarbonate
Fixing	Wall mountable
Degree of Protection	IP68
Flammability Rating	UL94 V-2/HB
Dimensions	215 mm x 125 mm x 90 mm
Weight	1.0 kg
Environmental	
Pipe temperature	-20.0 °C to 140 °C (-4 °F to 284 °F)
Operating temperature (Electronics)	0°C to 50 °C (32 °F to 122 °F)
Storage temperature	-10 °C to 60 °C (14 °F to 140 °F)
Humidity	90% RH at 50 °C Max
Display	
LCD	2 line x 16 characters
Viewing angle	Min 30°
Active area	58 mm(W) x 11 mm(H)
Keypad	
Format	4 key, tactile keypad with feedback

-  Servicing or repairs to the unit can only be carried out by the manufacturer.

7 FIXING AND ENCLOSURE DIMENSIONS

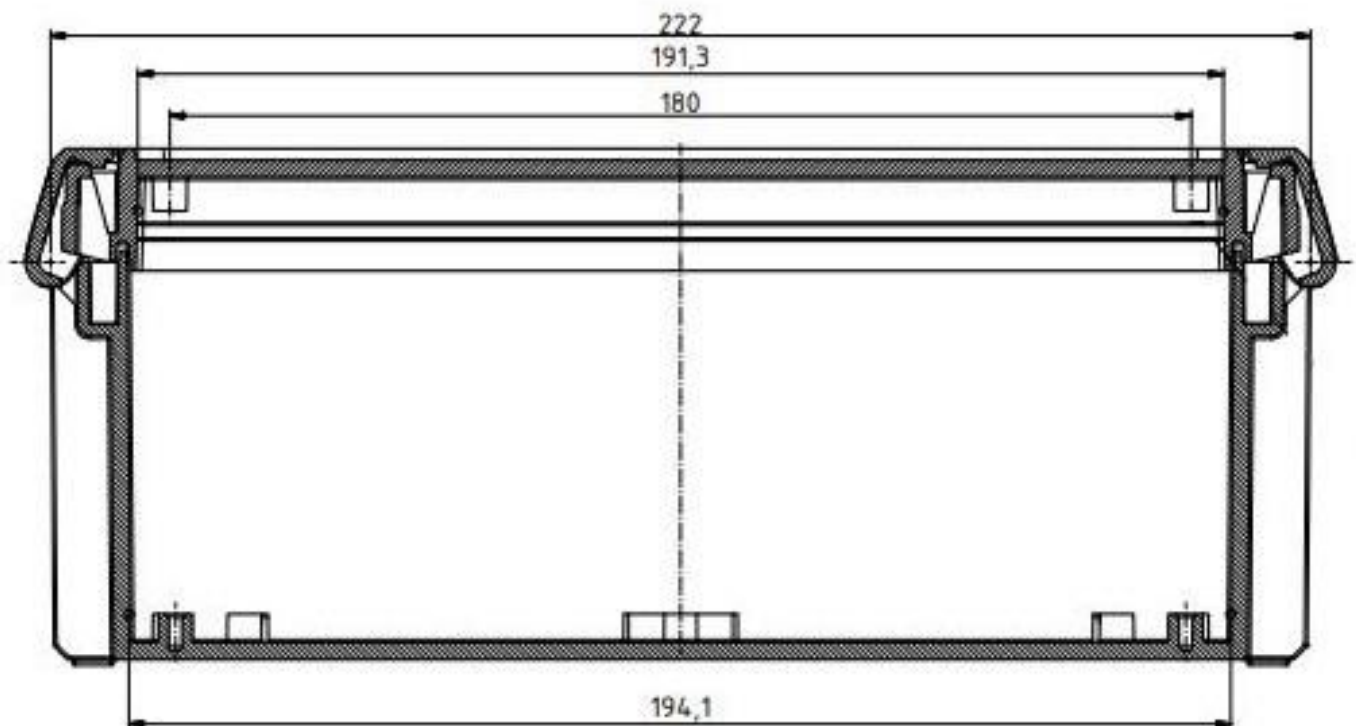
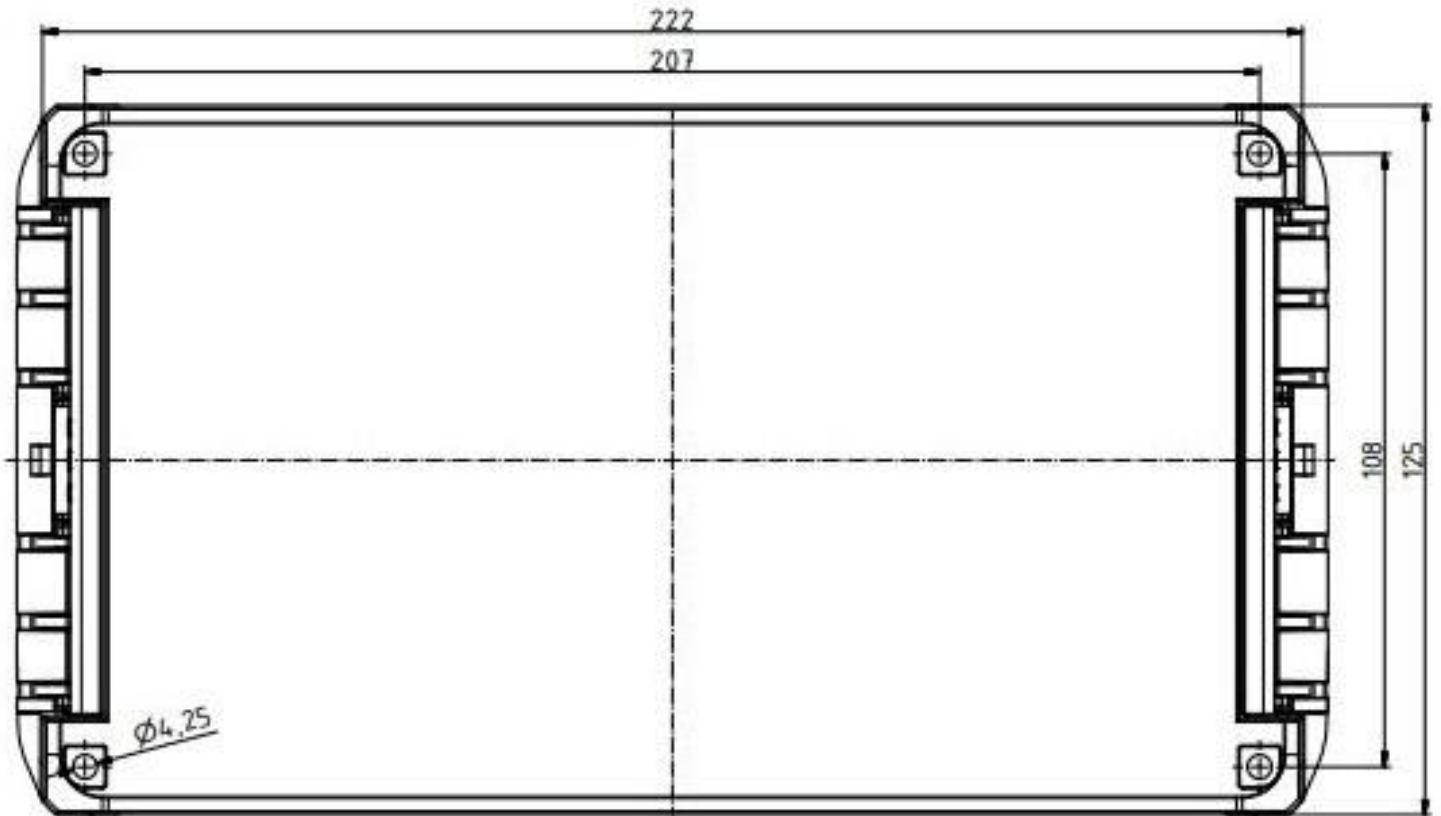

8 DECLARATION OF CONFORMITY

Contact Micronics for a copy.